

# Design and Manufacture of an Autonomous Surface Vehicle (ASV) for the 2014 RoboBoat Competition

June 15, 2014

*College of Engineering - University of Hawai'i at Mānoa*

## **Mechanical Engineering Team Members**

Francis Cheng • Sam Lewis • Zackary Main • Sheryl Matsuo • Scott Miyashiro Joshua Shigemitsu  
Kevin Shin • Yenmy Truong

## **Electrical Engineering Team Members**

Corey Chang • Tyler Ebisuzaki • Sean Hamada • Adam Oberbeck • Micheal Rollins • Jason Tanabe  
Chad Tanaka • Brock Wong

## **Mentors**

Dr. Brian Bingham • Dr. Song Choi • Dr. Tep Dobry • Dr. Wayne Shiroma • Dr. Zachary Trimble

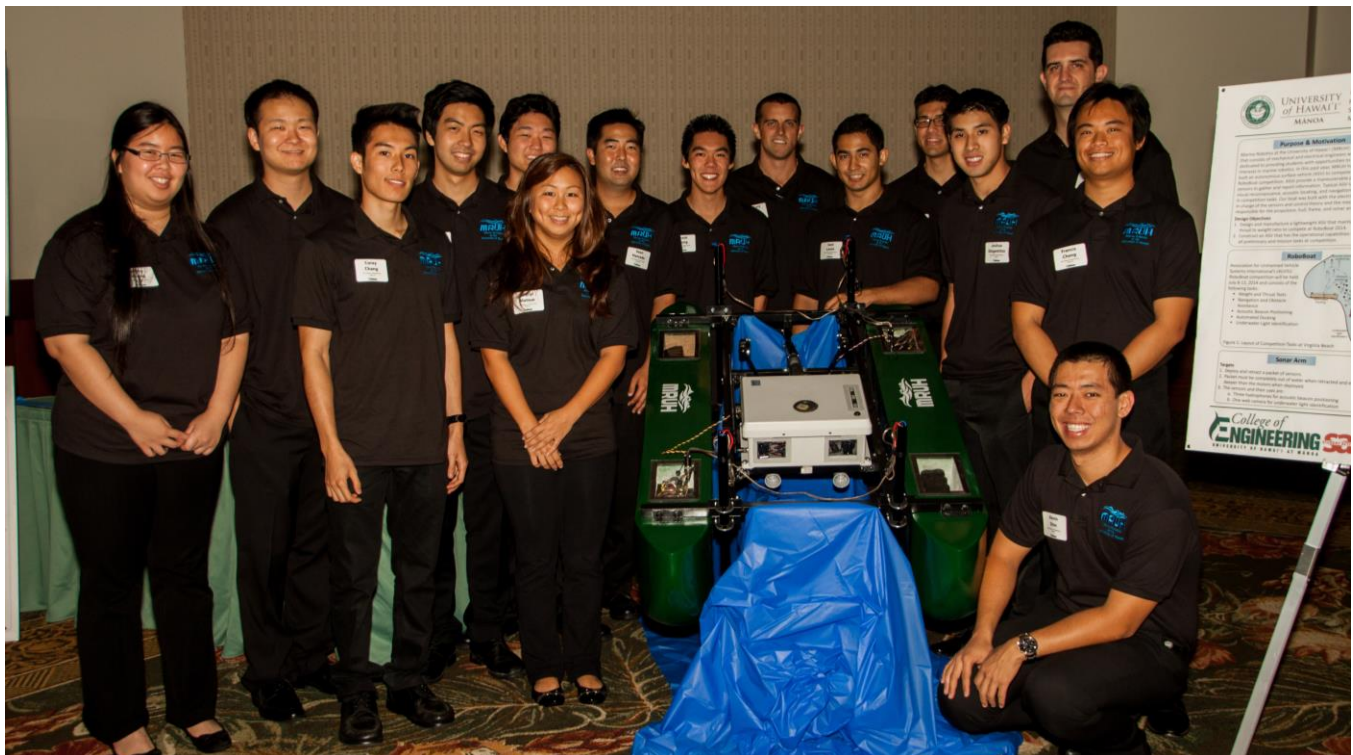

## Abstract

Due to the lack of student-driven projects in the field of marine robotics, a few students banded together to form Marine Robotics at the University of Hawai'i (MRUH). MRUH's mission was to get more students involved and interested in marine robotics and to pump out more interdisciplinary projects in the field. The first goal was to compete in the 2014 RoboBoat Competition. This will be the first time a team will be represented from the University of Hawai'i at Mānoa to compete. The team worked very hard this year to design and manufacture an autonomous surface vehicle (ASV) that could perform the tasks outlined in the 2014 RoboBoat rules. The final design was chosen based on what has worked in the past for other teams and what the team thought could be done better. The final design was catamaran style boat with four trolling motors, a fiberglass and epoxy hull, and many different electronics and sensors.

## 1. Design Philosophy

Knowing that being a first year competitor with no experience was going to be a daunting task, the overarching goal and theme this past year was to build a vehicle that worked. The team wanted to design and manufacture a vehicle that could minimally perform the tasks separately. From there, the challenge was linking them all up and getting the vehicle to perform all the tasks in order.

To do this, the autonomous surface vehicle (ASV) needed many things from all aspects of the team. It needed strong and maneuverable propulsion system, a stable platform to work on, a robust control system, and a host of sensors and electronics that could gather feedback and help the control system make decisions. All of these tasks referred back to the highest-level goal of accruing the most points to do well in the 2014 International RoboBoat Competition. To achieve all of this, the team was broken down into four main sub systems: hull and frame, propulsion, hardware, and software.

The final design came about a long hard process of looking at what previous year's teams have done, what the mentors had to say, and a lot of trial and error. The team was extremely lucky that there were subject matter experts so nearby due to the location of the school.

## 2. Vehicle Overview

The overview of the vehicle's systems can be shown in Figure 2.1.

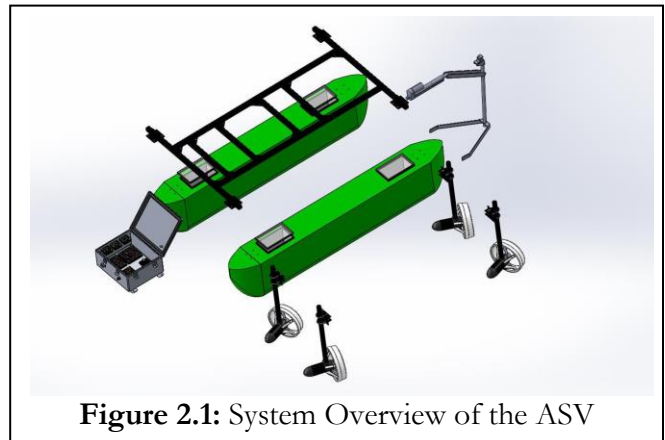

Figure 2.1: System Overview of the ASV

At a high level, the vehicle was made up of two catamaran-style hulls, a connecting frame, four trolling motors at an angle a box holding all the electronics, and an arm that deployed a host of sensors for the acoustic pinging and underwater light challenge.

## 3. Hull and Frame

The Hull and Frame team was responsible for the following things.

- Design and manufacture of hull

- Design and manufacture of frame
- Heat transfer experiments leading to electronics box choice

### 3.1 Hulls

There were four main parameters that determined the design of the hulls. They included weight, toughness, stability, and maneuverability. The hull team wanted a lightweight, strong, and maneuverable platform that would make it easy for the software side of the team to implement their control algorithms. The best choice for stability ended up being a catamaran-style (dual hull) system.

With the stability problem figured out, the hull team still had to tackle challenges of weight and maneuverability. The team met with Mark Kimura of the Small Vessel Fabrication and Repair Program at the Honolulu Community College. It was there that the team learned that a simple fiberglass and epoxy layup over expanded polystyrene foam would solve the weight and structural problems.

Afterwards, the hull team met with Daniel Rogers, who was a mechanical engineering masters student at the time whose thesis was on the drag characterization around catamaran hulls. It was there where the team learned how to design and dimension the hulls. The team also learned that the maximum speed of the vehicle is greatly determined by the hull speed. After the hull speed, there is a significant amount of drag compared to the thrust needed to overcome it.

The hulls' dimensions were as follows:

- Length: 61 in
- Width: 7.5 in
- Draft (bottom to water line): 5 in
- Weight: 10 lbs each
- Total Max Weight Supported: 105 lbs
- Hull Speed: 3.01 knots

The hulls were made of an interior core using 1.5 lb density expanded polystyrene (EPS) foam which also served as a male mold. An epoxy and fiberglass layup were done over that, much like how

surfboards are made. The foam was shaped in two different ways. First, the middle section was all the same and it was the easy part. The desired shape was modeled using software and 1/8" thick pieces of particle board were cut using a computer numerical controlled (CNC) mill. These boards were placed between blocks of foam as shown in Figure 3.1, and the foam was sanded down to that desired shape. The tips of the hulls were small enough where they could be shaped entirely in the CNC machine. The foam kept the shape and the structure and the fiberglass made the hulls strong and light.

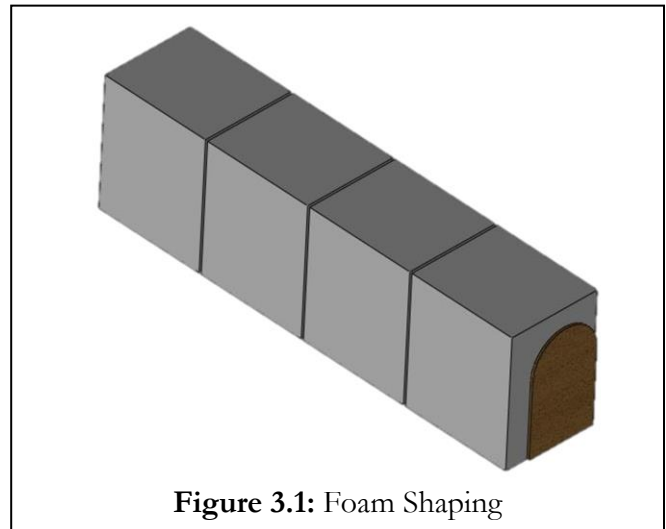

Figure 3.1: Foam Shaping

### 3.2 Frame

The frame was important in two ways. It had to be structurally sound enough to hold everything together while withstanding the forces and moments from the motors and there had to be enough space for everything that was needed.

To save weight, it was decided that a full platform was not necessary, and that a bare frame to attach things to would suffice.

The frame was made with 1/16 in thick, 1 in wide aluminum square tubing. All in all, the frame weighed in at about 5 lbs. Figure 3.2 shows the outer dimensions of the frame before all the attachments were added to it.

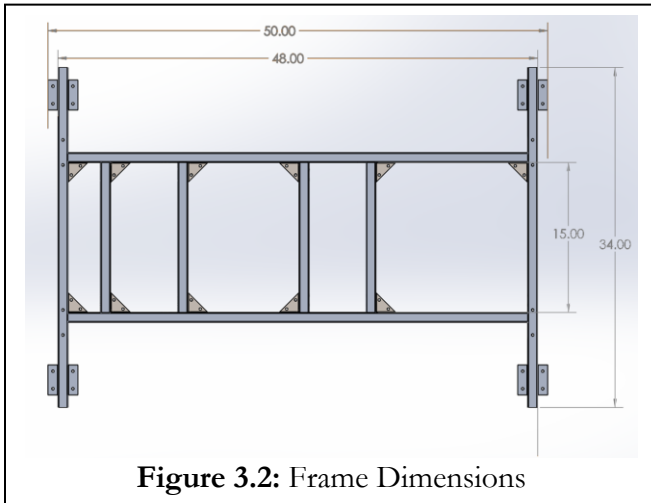

**Figure 3.2:** Frame Dimensions

### 3.3 Electronics Box

The housing for the electronics box was initially a huge problem to tackle. It had to be water tight to protect the electronics but that also means that heat could build up very easily.

An aluminum box was considered but problems were soon found with the GPS and the XBEE which were inside the box. The aluminum material interfered with the communication between inside and outside of the box.

The next option was a fiberglass box. There was some worry of the heat dissipation but it worked much better in terms of communication. The heat problem was solved by taking the highest heat generating components which were the Talon motor controllers and putting them in the hulls instead of the box. Tests were run while operating and it showed that the temperature inside the box did not heat up a lot. The fiberglass box was the final choice.

## 4. Propulsion

The Propulsion team was responsible for the following items:

- Motor choice
- Motor placement and orientation
- Motor testing

- Design and Manufacture of shrouds
- Design and manufacture of sonar arm

### 4.1 Motor Choice

The motors chosen for the ASV were Sevylor 12V, 18 lb thrust trolling motors as shown in Figure 4.1. They weigh approximately 3.5 lbs and are compact in size. The propellers are 4 inches in diameter and the motor itself is 7 inches long. It has a aluminum shaft that is 18 inches long, which was modified for the final design, and 15/16 inches outer tube diameter. The motor is rated to produce 18 lbs of thrust at maximum amperage of 18 amps and comes with a keel to deflect weeds in the water. The motor is relatively cheap (\$96.63) and can be purchased through Amazon with free shipping. Unfortunately, the motor does not have a shroud so one was manufactured. Another downside is that the propellers were very fragile due to them being made from thin plastic that was easily nicked and damaged. New, Minn Kota propellers were purchased and modified to fit our motor. This allowed for spare propellers and also was able to provide on average of an additional 1 lb of thrust on each motor.



**Figure 4.1:** Sevylor Trolling Motor



This motor was selected due to its lightweight nature compared to other trolling motors. It is three times lighter than the next lightest trolling motor made by Minn Kota. The lightweight nature of the motor allows for the ASV to stay under the projected weight of 70 lbs, providing eligibility to earn the extra points from the weight requirements. The high thrust output means the ASV will travel at a higher velocity, which would result in a higher score for the thrust and speed tests. Also, the high thrust output means the ASV can turn faster, making it more agile.

#### 4.2 Motor Placement and Orientation

To maximize maneuverability, it was decided by the propulsion team that there should be four trolling motors mounted at an angle. The four motors provided more thrust while still being light weight. The angling of the motors allowed for tighter turns and lateral movement and determined how much force the thrusters exert in each direction. Ultimately, the thruster angle was determined to be 15 degrees. At 15 degrees, the forward force is still near its maximum and allows the boat to reach its hull speed. At the same time, from testing, the boat displays agile capabilities. The angles allow the thrusters to provide enough moment on the boat to enable it to weave between obstacles and turn with a zero degree turning radius. With this achievement, the thruster configuration fulfills the design objective of having a quick and agile boat capable of moving in all desired degrees of freedom.

#### 4.3 Motor Shrouds

While a shroud is required by competition rules, it also can benefit the ASV. A shroud, if designed properly, can increase the static thrust of the motors. This occurs because it reduces tip vortices, which increases efficiency. This would directly benefit the ASV for the thrust test, and can maximize the potential score. However, the main

goal for the shroud is to protect the blades while not causing too much drag.

The current design for the shroud is based off of the Rice thrust nozzle design, which is shown in Figure 4.2. This shroud is designed to increase efficiency at low velocities (<10 knots) which is where the ASV is expected to operate at. The leading nozzle designs are the Rice nozzles and Kort nozzles. In a test which had its results certified by Bureau Veritas, it was found that the Rice thrust nozzle system outperformed the Kort 37 nozzle. The test, which was performed using two tug vessels, found that the Rice thrust nozzle achieved an increase in fuel savings, running speed, bollard pull, and more trawling thrust when compared to the Kort nozzle. The Rice thrust nozzle also is expected to give the motor an increase of thrust by about 8-11% [1].

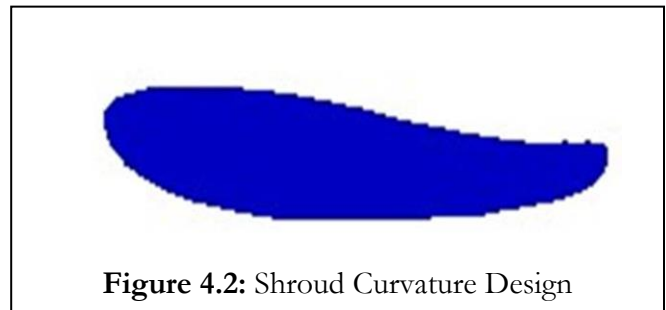

The SolidWorks model of the shroud design is shown in Figure 4.3. The shroud was 3D printed using Acrylonitrile butadiene styrene (ABS) plastic in four parts and put together.

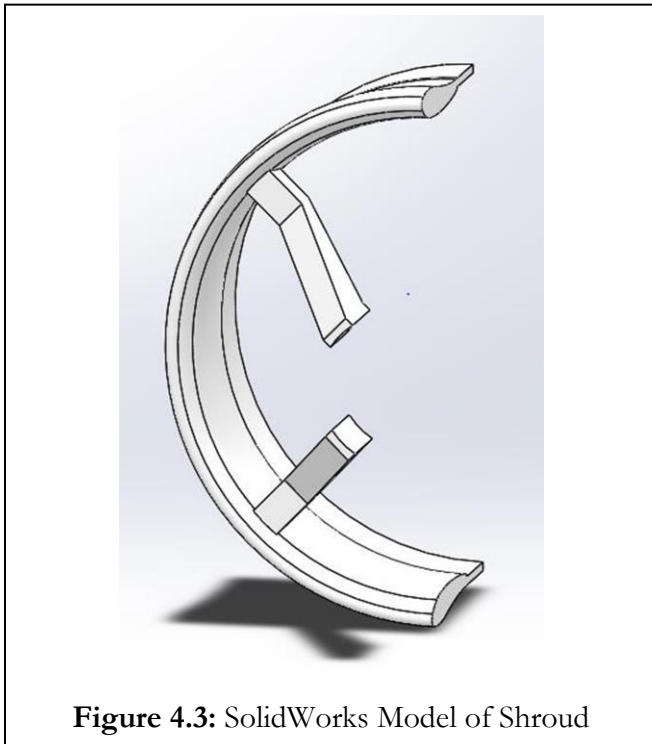
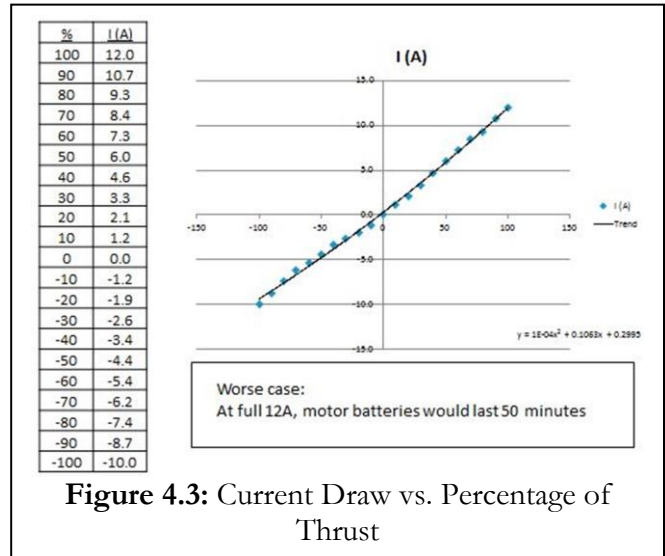

Figure 4.3: SolidWorks Model of Shroud

#### 4.4 Motor Testing

Motor testing was a key focus for the propulsion team and great effort was made to characterize the motors. The first test was to determine the amount of current draw the motors were taking from their motor controllers (Figure 4.4). In general, for trolling motors the amount of current being drawn is near identical from the amount of pounds of force delivered. So at the 100% max draw of 12 amps, the amount of thrust from each motor was expected to be in the range of 10-12 lbs. The time of operation was also determined and at worst case the batteries would last for 50 minutes.



The next test was to determine the amount of static thrust per motor. This was done by setting up a static rig where a load cell was connected to a motor and measured the amount of thrust generated. Each motor was tested and was found to be similar enough to where the motor control would correct for any minor differences. The stock propeller on the trolling motor was swapped out for a larger propeller developed by Minn Kota. From this the propulsion team was able to increase the thrust of each motor on average by a 1 lb as can be seen on the table below. The amount of predicated force from the current draw was also verified as the motors are able to deliver on average 10.76 lbs of force at 12 amps.

Table 4.1 Results from Motor Testing

(lbf)	Forward Static Thrust		
	50%	70%	100%
Stock Propeller	3.91	6.11	9.80
New Propeller	4.67	7.29	10.76

The last test the propulsion team did was to determine how fast the ASV could go. This was done by taking a series of time trials and determining the speed. From the design of the hulls it was estimated that the ASV would go 3.1 knots before hitting a drag barrier. Through testing it was

seen that our average top speed at 100% was 3.16 knots (Figure 4.5) verifying the design of the hulls.

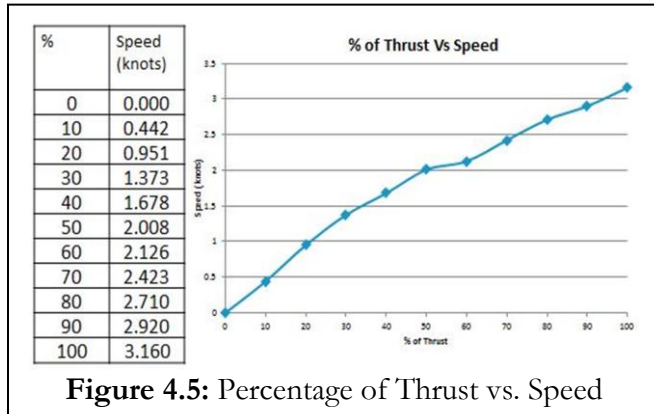

#### 4.5 Sonar Arm

The sonar arm was made to meet the needs of two of the challenges in the 2014 RoboBoat Competition. They were the Acoustic Beacon Pinging Challenge and the Underwater Light Identification challenge. Both of these challenges required sensors underwater and occurred at the end of the course. It was decided that it was not necessary to mount sensors permanently underneath since it was not needed at all times. The team decided to manufacture an arm that would lower when needed and retract when it wasn't needed. This feature would allow for underwater drag to be minimized and lower the risk of underwater collision.

The sonar arm's design consists of a twenty inch long arm driven, via a linkage, by a horizontally-positioned linear actuator. The linear actuator used was the PA-14-6-150 Mini Linear Actuator it has 150 lbs of axial force and can withstand 50-70 lbs of side loading. Through analysis and knowing the restrictions of the actuator, the sonar arm was designed to have a 1.3 factor of safety (FOS) to a collision impact and a 1.25 FOS from underwater entanglement. Below contains the final dimensions of the sonar arm.

**Table 4.2** Sonar Arm Final Dimensions

Arm Length [in.]	Linkage to Pivot Distance [in.]	Linkage Length [in.]	Maximum Stroke Length [in.]	Pivot Offset [in.]
20	3.00	11.5	6	3.25

The cluster of sensors, consisting of a camera and three hydrophones spaced at the vertices of an equilateral triangle with twelve inch long sides, is attached at the end of the arm. The design is shown below in Figure 4.6.



## 5. Hardware

The Hardware team was responsible for the following:

- Electrical Components
- Printed Circuit Board (PCB) Design

### 5.1 Electrical Components

The AUV is required to traverse though five different mission tasks. To accomplish all of these

tasks the AUV was equipped with several different sensors.

First are the cameras to receive the visual information from obstacles to targets. The camera chosen was an USB webcam, these cameras were small, have high resolution and are low cost. There are three separate cameras on the AUV. Two are used to observe in front of the AUV given stereo vision and allowing distances to be measured off of the different placement of obstacles in the cameras view. The last camera is potted and mounted onto the linear actuator arm to be the AUVs underwater camera for the last mission.

There are a number of other sensors to assist in the missions including GPS, gyro, accelerometer, and compass to assist in the navigation of the AUV. The AUV needs to be able to also receive a submerged beacon signal for the pinging buoy mission. Three passive sonar elements are attached to the linear actuator arm to provide directional clues to the buoy. Ultrasonic range finders are attached to the component box to give accurate distances of the docks and other objects as the AUV approaches them.

The trolling motors require a large amount of current that could not be supplied by the micro controller. To bridge the connection four motor controllers were placed in the hulls allowing the micro controller to send a pulse width modulated signal to the motor controllers and that signal would be translated to the 12 volt signal and be able to supply the current needed.

Three battery banks were used to provide some redundancy and to reduce analog noise on the digital power lines. There is one battery bank in each of the hulls providing the 12 volt sources and a capacity of 20 amp hours. A 7.2 volt battery bank is placed inside the electronics box proving the digital power supply with a capacity of 2 amp hours.

## 5.2 Printed Circuit Board (PCB) Design

The AUV's electrical hardware is manly comprised of three different PCBs; a power PCB, a

Micro controller unit (MCU) PCB, and the PCB that links the sensors and motors to the MCU.

There is one power PCB which handles delivering the three different voltages required to run all the components. This is accomplished by using a switching voltage regulator, stepping down the voltages from the 7.2 volt battery bank to 3.3 and 5 volts. 12 volts comes straight from the two main battery banks which also supplies the motors with current.

The MCU PCB simplifies the connections to the "brains" of the boat. All the power, communication protocols, and general ports for in and out (GPIO) are broken out simple to use plugs and pin headers which enable the MCU PCBs to be stacked with the sensor and motor PCB. There are three MCU board on the AUV. One of the MCUs is for the motor controller and for the wireless communication. Another MCU is for receiving and interpretation of the information coming from the sensors. The final MCU is to perform the navigation calculation for the AUV.

The sensor and motor PCB allows the external devices to be connected to the MCU. On the board there are a series of cascading op-amps providing a filter and amplification to the boats sonar and ultrasonic rangefinders. There are also motor drivers for both dc and stepper motors along with a connection to the GPS, XBEE and the inertial measurement units (IMU). There are two of these boards on the AUV. One is mated with the motor controller MCU to provide the link to the motor and wireless communication. Changing the voltage of the MCU signals to the required 12 volt levels for the motors. The second board is mated with the sensor MCU providing the connection to the GPS, IMU, sonar, and ultrasonic rangefinders.

## 6. Software

The Software team was responsible for the following:

- Communications
- Inertial Measurement Unit
- Motor Control
- Image Processing



- Navigation

## 6.1 Communications

The electronic hardware setup of the boat was designed on a budget and because of this the choice to use multiple micro-controllers (MCU) was used in place of a full size computer. Since there were multiple MCU in place of a single CPU communication became an issue.

To solve the issue of multi-MCU communication the chosen communication protocol between all controllers was Serial Peripheral Interface (SPI). This was chosen due to the ease of configuration, speed of data transfer, and short travel distance. It is a single master multi-slave interface and because of this made perfect sense to create three different bus lines.

The three different bus lines each give feedback that specific MCUs required to accomplish their tasks which were navigation, control, and image processing. The control bus connected the IMU to the motor control and navigation MCUs, the navigation was connected between the navigation and motor control MCUs, and the image processing bus is connected to between the image processing SOC and navigation MCU. This allows for all needed feedback to reach their required destinations.

## 6.2 Inertial Measurement Unit (IMU)

The AUVSI competition gave a unique challenge, water, and because of this standard encoders to log distance traveled was not a valid solution. This led to the integration of an inertial measurement unit (IMU) which consisted of GPS, gyroscope, magnetometer and accelerometer. Each which aid in giving the boat speed and position.

The GPS does double duty, the AUVSI competition will be giving GPS coordinates for the various tasks. However the GPS is also used to determine speed and relative position by integrating the difference over time from the GPS coordinates. The magnetometer and the gyroscope were used in

determine heading, the gyroscope and magnetometer are both used as a double check to the feedback given by both since a magnetometer is extremely sensitive to magnetic interference and the gyroscope will drift over time. Finally, the accelerometer was used as a check to the calculations derived from the GPS coordinates to add robustness to the system.

## 6.3 Motor Control

The controller takes velocity feedback from the IMU and a coordinate from the navigation to determine how to control each motor to get to the desired coordinate. The motor controller MCU accomplishes this using a basic position control.

The position controller works by controlling the speed of the boat based on position instead of controlling the velocity or acceleration directly. The underlying control layer beneath this is a PID controller which works on the difference between actual position and incremented position to control the PWM output for each motor and will cap at predetermined velocities and acceleration to allow for more stability.

## 6.4 Image Processing

The AUVSI competition requires a way to acquire and differentiate different types of targets and the color of these targets. Each mission task has a well defined set of targets with specific colors and rules, because of this image processing was the most efficient way of accomplishing this.

The image processing library OpenCV was used to acquire targets taken from a web camera. OpenCV was chosen due to the amount of documentation and the availability of Python bindings allowing for fast efficient coding.

The basic algorithm used to extract targets of interest from a picture is to first filter the image for only the specific colors of the target of interest. Following this the image is then converted to a binary image and is then eroded, which fills in noise

caused by shadows or picture imperfection, then the image is dilated to reconstruct and smooth the edges of the colored objects. After these steps contours in the image are then searched for and approximation algorithms give the amount of corners in the contour, using this number the object is then identified. For example a triangle is three corners, a square is four corners, a cross is twelve corners and a circle is greater than twelve corners.

Another task that the image processing needs to accomplish is after finding a target is to determine the distance from the camera to the object as well as the position relative to the boat. To solve this task the competition gives specific measurements for each target and this is compared to the bounding rectangle around each target. With these measurements the distance to the object can be derived, the position of the object is then determined using the center of mass of the object and its position in the picture to determine a relative position.

## 6.5 Navigation

The AUVSI competition takes place in a relatively large area. Using GPS and image processing feedback the navigation MCU needs to determine the best course of action to get the boat to its required destination.

To accomplish this, the object data from the image processing SOC is plotted on a grid. Each object plotted is given a size, this size is based on boat maneuverability and expected error. For each task there is a start and end goal point and then using A-star the algorithm then calculates the most efficient route from the start point to the end point while avoiding the objects plotted from the image processing SOC. The route taken is done in straight vectors which allow for logging each point in between the start and end points which can then be sent to the motor control MCU.

## 7. Conclusion

The University of Hawai'i at Mānoa will be represented for the first time at the 2014

International RoboBoat Competition. The team has worked very hard this year and is excited to compete. There were many mistakes made along the way but the team is confident that they can be a contender in this year's competition. MRUH has built a system that can tackle the challenges that were put forth by the Association for Unmanned Vehicle Systems International (AUVSI). Although confident, the team is definitely planning for the long run. This is only the first year and they expect to learn from this year to build better platforms in the following years.

## 8. Acknowledgements

We would like to extend our greatest gratitude to all those that helped at supported us. Without the following people, we could not have achieved all that we have with what little resources we had.

First, we'd like to thank our mentors for helping us with technical issues and project management issues along the way. They were Dr. Brian Bingham, Dr. Song Choi, Dr. Tep Dobry, Dr. Wayne Shiroma, and Dr. Zachary Trimble.

We'd also like to thank our generous sponsors for giving us the resources and thus, the opportunity to work on this project. Our sponsors include the College of Engineering at the University of Hawai'i at Mānoa, the Boeing Company, the Student Activity and Program Fee Board, the Associated Students of the University of Hawai'i, SolidWorks, and Fiberglass Hawai'i.

There were also many others who donated their time and expertise to help make this project successful. We'd like to thank Daniel Arakaki, David Horton, Mark Kimura, Daniel Rogers, Michelle Teng, Aaron Toyama, and Brennan Yamamoto for helping with resources, time, and/or their expertise!

## 9. References

[1] D. B. & R. Olds, "Maximizing Propulsion Efficiency," Olds Engineering, [Online]. Available: [http://www.olds.com.au/marine/maximizing\\_propulsion\\_efficiency/](http://www.olds.com.au/marine/maximizing_propulsion_efficiency/) [Accessed 2014].